

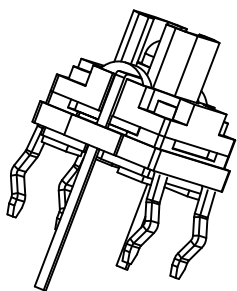

TS5

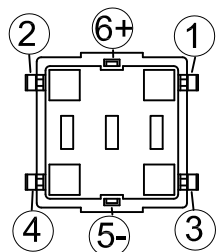
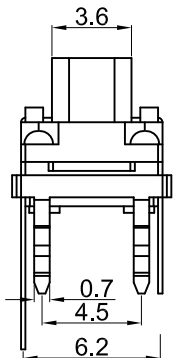
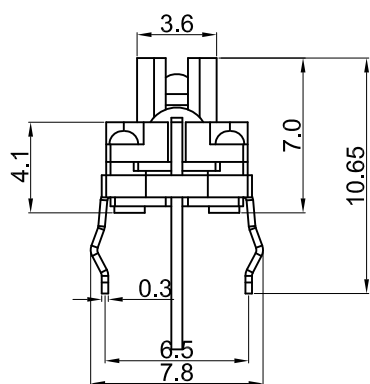
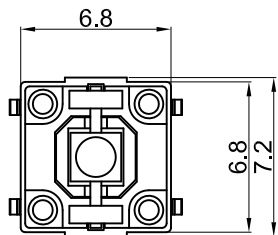

Specifications

- Circuit :SPST
- Current rating :50mA
- Voltage rating :12VDC
- Dielectric withstanding voltage:250VAC for 1 minute
- Contact resistance :100mΩ Max. (Initial)
- Insulation resistance :100MΩ Min.
- Operating force :250±50gf
- Total travel :0.35±0.1mm
- Operating life :100,000 cycles Min
- Solder specifications :260° C for 5 seconds
- Function :Momentary
- Operating temperature :+10° C ~ +60° C

P.C.B. LAYOUT

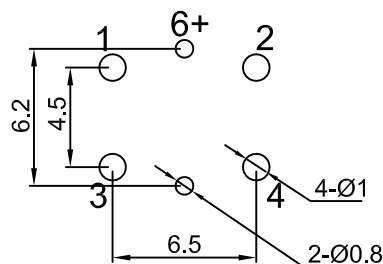

CIRCUIT

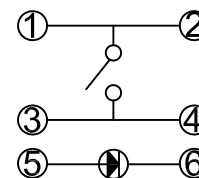

MATERIAL:

- Base Frame:Nylon46,UL rated:94V-2 Min. ;
- Top Cover:PET,UL rated:94V-2 Min. ;
- Actuator: Nylon66, UL rated:94V-2 Min. ;
- Terminal:Brass with Silver-plate.

BG	纯绿色	3.2	3.7	4.2	20	120	515	525
W	白色	2.8	3.4	3.8	20	120	XY	XY
O	橙色	1.8	2.2	2.4	20	120	620	634
RU	蓝色	2.8	3.2	3.4	20	120	460	470
	红色	1.8	2.2	2.4	20	120	620	630
U	蓝色	2.8	3.2	3.4	20	120	460	470
G	黄绿色	1.8	2.2	2.4	20	120	563	575
Y	黄色	1.8	2.2	2.4	20	120	582	588
R	红色	1.8	2.2	2.4	20	120	620	630
灯发光颜色 X Emitted color X	最小	一般	最大	最大操作电压(V)	最大操作电流(mA)	最大脉冲电流(mA)	主波长(nm)	峰值波长(nm)

				公差 TOLERANCES		.X± 0.3 .XX± 0.15		角度 ± 1°		单位 DIMENSION UNIT mm.	
				版本 VERSION	A1	比例尺 SCALE	NONE	日期 DATE	2020.07.10	品名 TITLE	
				核准	王龙	核对	Z. H. B.	绘图		图号 DRAWING NO	
A1	重新整理发行			2020.07.10	N/A	核审		绘图		TS5-00-00R-1	
版本 VER.	变更说明 CHANGE DESCRIPTION			日期 DATE	ECN NO.	核审		绘图		TS5-00-00R-1_A1	